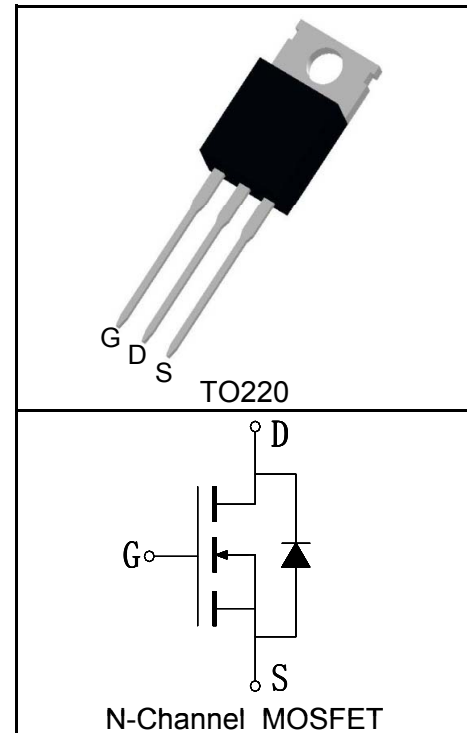

Features

- 80V/120A,
 $R_{DS(ON)} = 5.5m\Omega(Typ.)@V_{GS}=10V$
- Super High Dense Cell Design
- Fast Switching
- 100% avalanche tested
- Lead Free and Green Devices Available (RoHS Compliant)

Pin Description

Applications

- Switching Application Systems

Absolute Maximum Ratings

Symbol	Parameter	Rating	Unit
Common Ratings ($T_C=25^\circ C$ Unless Otherwise Noted)			
V_{DSS}	Drain-Source Voltage	80	V
V_{GSS}	Gate-Source Voltage	± 25	
T_J	Maximum Junction Temperature	175	$^\circ C$
T_{STG}	Storage Temperature Range	-55 to 175	$^\circ C$
I_S	Diode Continuous Forward Current	$T_C=25^\circ C$ 120	A
Mounted on Large Heat Sink			
$I_{DP}^{①}$	300 μs Pulse Drain Current Tested	$T_C=25^\circ C$ 480	A
$I_D^{②}$	Continuous Drain Current($V_{GS}=10V$)	$T_C=25^\circ C$ 120	A
		$T_C=100^\circ C$ 85	
P_D	Maximum Power Dissipation	$T_C=25^\circ C$ 158	W
		$T_C=100^\circ C$ 79	
$R_{\theta JC}$	Thermal Resistance-Junction to Case	0.95	$^\circ C/W$
$R_{\theta JA}$	Thermal Resistance-Junction to Ambient	62.5	$^\circ C/W$
Drain-Source Avalanche Ratings			
$E_{AS}^{③}$	Avalanche Energy, Single Pulsed	900	mJ

Electrical Characteristics ($T_C=25^\circ\text{C}$ Unless Otherwise Noted)

Symbol	Parameter	Test Condition	RU85120R			Unit
			Min.	Typ.	Max.	
Static Characteristics						
BV_{DSS}	Drain-Source Breakdown Voltage	$V_{GS}=0V, I_{DS}=250\mu A$	80	87		V
I_{DSS}	Zero Gate Voltage Drain Current	$V_{DS}=80V, V_{GS}=0V$			1	μA
		$T_J=125^\circ C$			30	
$V_{GS(th)}$	Gate Threshold Voltage	$V_{DS}=V_{GS}, I_{DS}=250\mu A$	2		4	V
I_{GSS}	Gate Leakage Current	$V_{GS}=\pm 25V, V_{DS}=0V$			± 100	nA
$R_{DS(ON)}^{(4)}$	Drain-Source On-state Resistance	$V_{GS}=10V, I_{DS}=75A$		5.5	6.5	m Ω
Diode Characteristics						
$V_{SD}^{(4)}$	Diode Forward Voltage	$I_{SD}=75A, V_{GS}=0V$			1.2	V
t_{rr}	Reverse Recovery Time	$I_{SD}=75A, di_{SD}/dt=100A/\mu s$		53		ns
Q_{rr}	Reverse Recovery Charge			92		nC
Dynamic Characteristics ⁽⁵⁾						
R_G	Gate Resistance	$V_{GS}=0V, V_{DS}=0V, F=1MHz$		1.2		Ω
C_{iss}	Input Capacitance	$V_{GS}=0V,$ $V_{DS}=40V,$ Frequency=1.0MHz		4800		pF
C_{oss}	Output Capacitance			560		
C_{riss}	Reverse Transfer Capacitance			370		
$t_{d(ON)}$	Turn-on Delay Time	$V_{DD}=40V, I_{DS}=75A,$ $V_{GEN}=10V, R_G=5\Omega$		26		ns
t_r	Turn-on Rise Time			88		
$t_{d(OFF)}$	Turn-off Delay Time			77		
t_f	Turn-off Fall Time			73		
Gate Charge Characteristics ⁽⁵⁾						
Q_g	Total Gate Charge	$V_{DS}=65V, V_{GS}=10V,$ $I_{DS}=75A$		118		nC
Q_{gs}	Gate-Source Charge			27		
Q_{gd}	Gate-Drain Charge			45		

- Notes:
- ① Pulse width limited by safe operating area.
 - ② Calculated continuous current based on maximum allowable junction temperature. The package limitation current is 75A.
 - ③ Limited by T_{Jmax} , $I_{AS}=35A$, $V_{DD}=48V$, $R_G=50\Omega$, Starting $T_J=25^\circ C$.
 - ④ Pulse test; Pulse width $\leq 300\mu s$, duty cycle $\leq 2\%$.
 - ⑤ Guaranteed by design, not subject to production testing.

Ordering and Marking Information

Device	Marking	Package	Packaging	Quantity	Reel Size	Tape width
RU85120R	RU85120R	TO220	Tube	50	-	-

Typical Characteristics

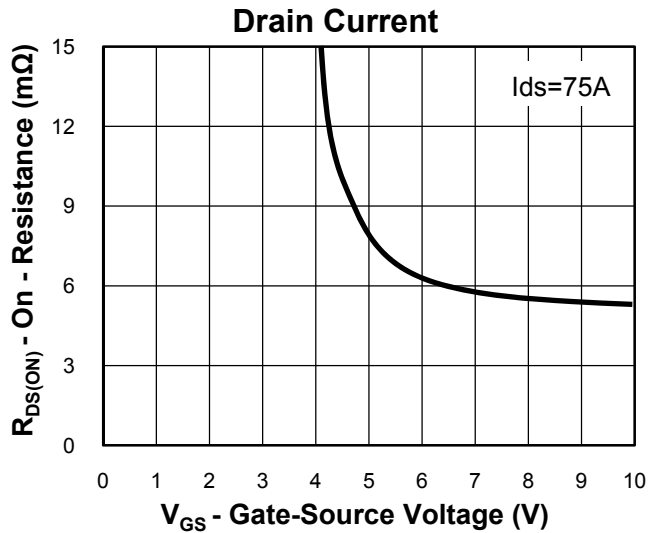
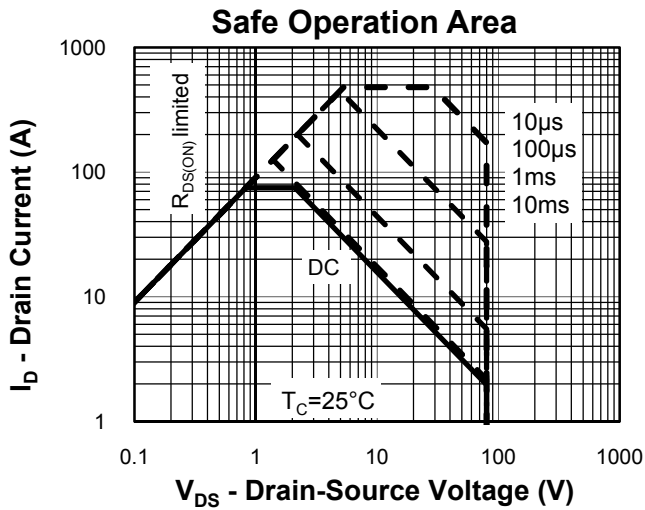
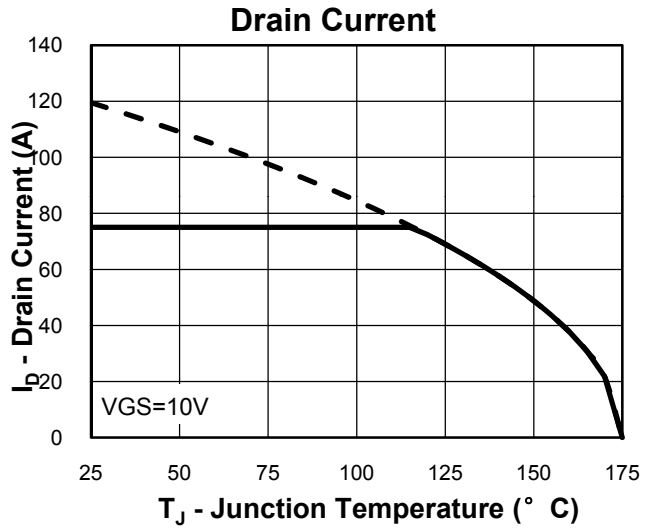
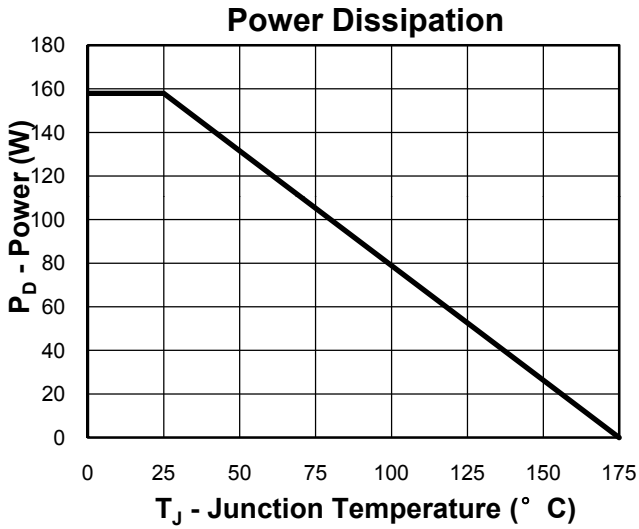

Thermal Transient Impedance

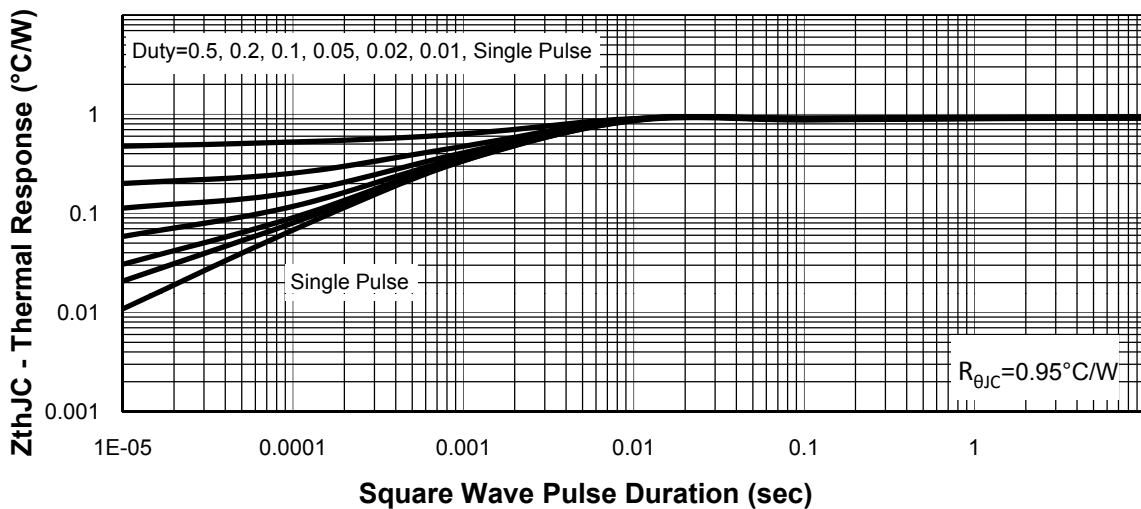

Typical Characteristics

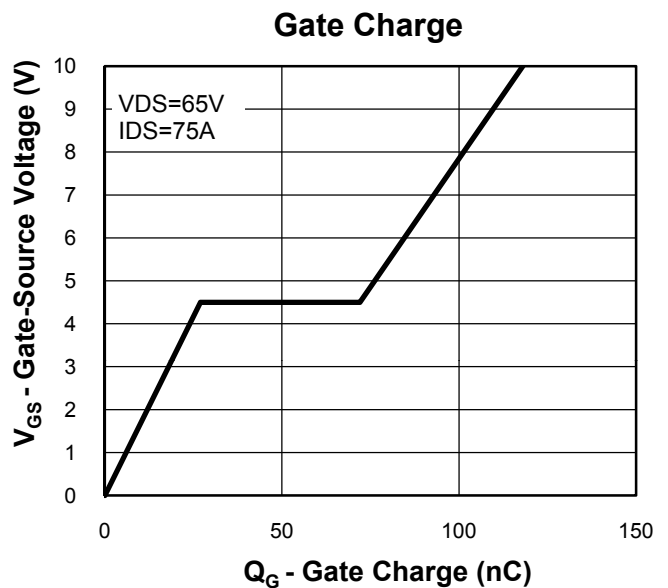
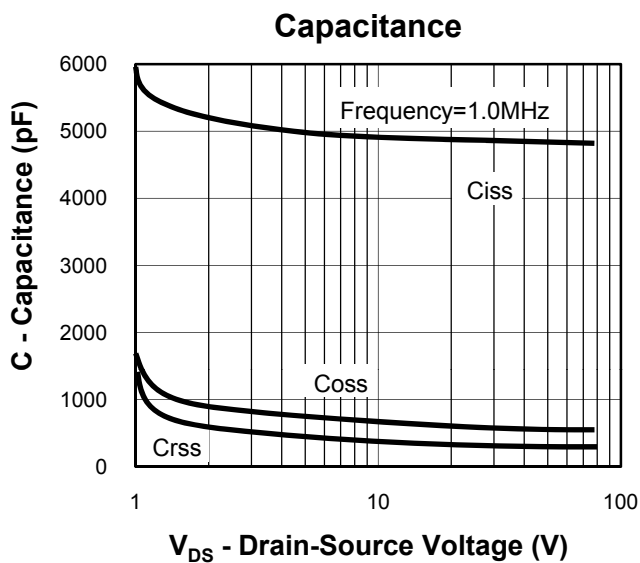
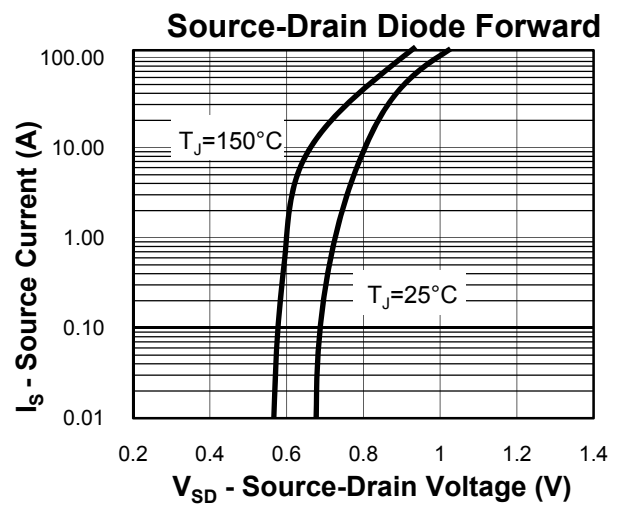
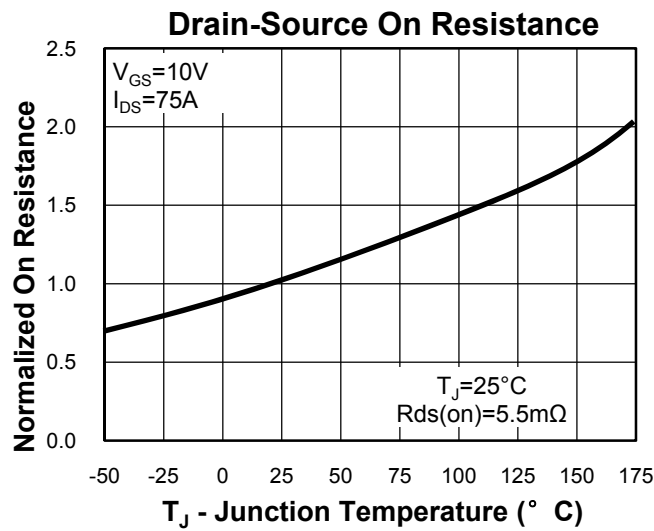
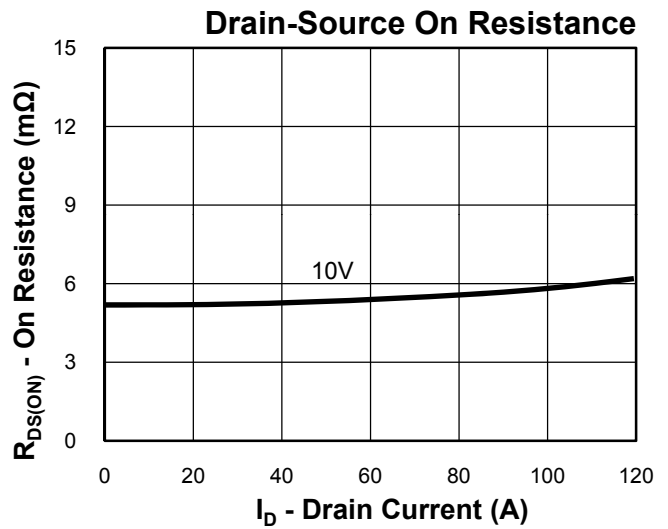
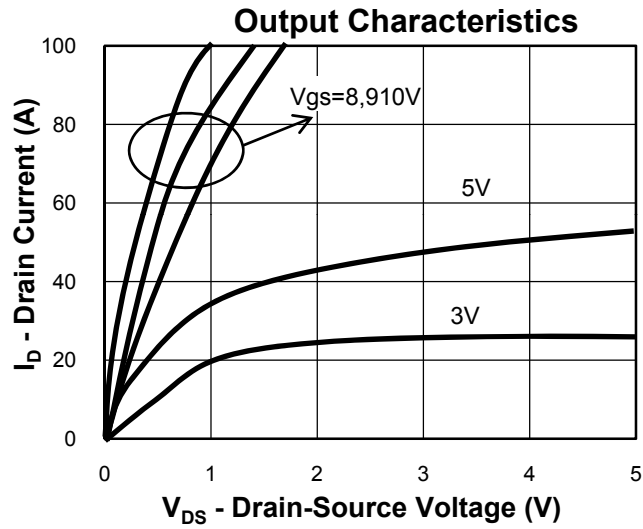

Avalanche Test Circuit and Waveforms

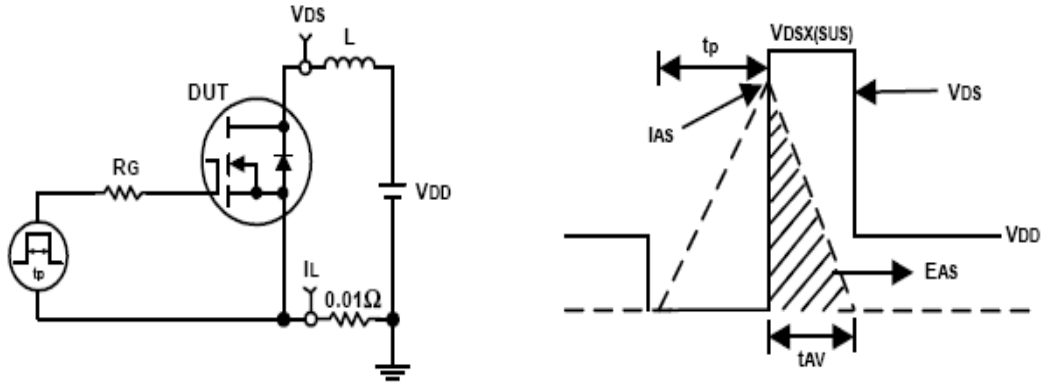

Switching Time Test Circuit and Waveforms

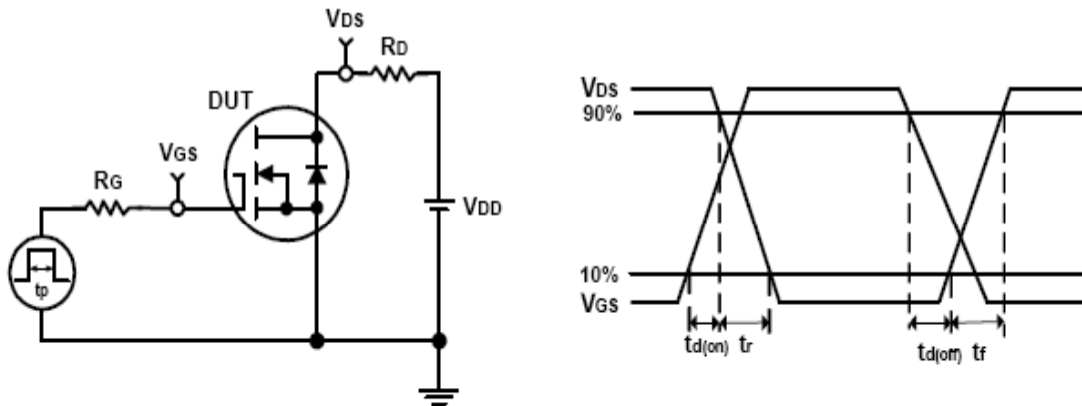

Package Information

TO220

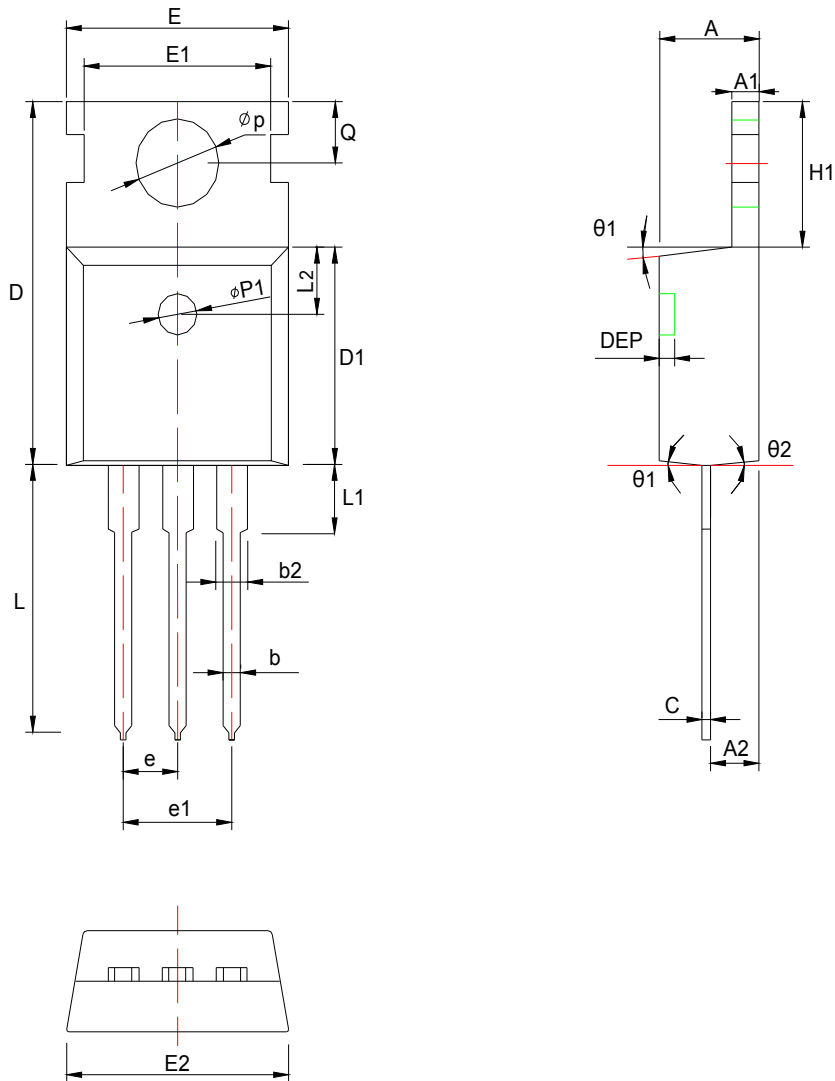

SYMBOL	MM			INCH			SYMBOL	MM			INCH		
	MIN	NOM	MAX	MIN	NOM	MAX		MIN	NOM	MAX	MIN	NOM	MAX
A	4.40	4.55	4.70	0.173	0.179	0.185	$\Phi p1$	1.40	1.50	1.60	0.055	0.059	0.063
A1	1.20	1.30	1.40	0.047	0.051	0.055	e	2.54 BSC			0.10 BSC		
A2	2.23	2.38	2.53	0.088	0.094	0.100	e1	5.08 BSC			0.20 BSC		
b	0.75	0.80	0.85	0.030	0.031	0.033	H1	6.40	6.50	6.60	0.252	0.256	0.260
b2	1.17	1.28	1.39	0.046	0.050	0.055	L	12.70	13.18	13.65	0.500	0.519	0.537
c	0.40	0.50	0.60	0.016	0.020	0.024	L1	*	*	3.95	*	*	0.156
D	15.40	15.60	15.80	0.606	0.614	0.622	L2	2.50 REF			0.098 REF		
D1	8.96	9.21	9.46	0.353	0.363	0.372	Φp	3.50	3.60	3.70	0.138	0.142	0.146
DEP	0.05	0.13	0.20	0.002	0.005	0.008	Q	2.73	2.80	2.87	0.107	0.110	0.113
E	9.66	9.97	10.28	0.380	0.393	0.405	$\theta 1$	5°	7°	9°	5°	7°	9°
E1	*	8.70	*	*	0.343	*	$\theta 2$	1°	3°	5°	1°	3°	5°
E2	9.80	10.00	10.20	0.386	0.394	0.402							

Customer Service

Worldwide Sales and Service:
Sales@ruichips.com

Technical Support:
Technical@ruichips.com

Investor Relations Contacts:
Investor@ruichips.com

Marcom Contact:
Marcom@ruichips.com

Editorial Contact:
Editorial@ruichips.com

HR Contact:
HR@ruichips.com

Legal Contact:
Legal@ruichips.com

Shen Zhen RUICHIPS Semiconductor CO., LTD
Room 501, the 5floor An Tong Industrial Building,
NO.207 Mei Hua Road Fu Tian Area Shen Zhen City, CHINA

TEL: (86-755) 8311-5334
FAX: (86-755) 8311-4278
E-mail: Sales-SZ@ruichips.com