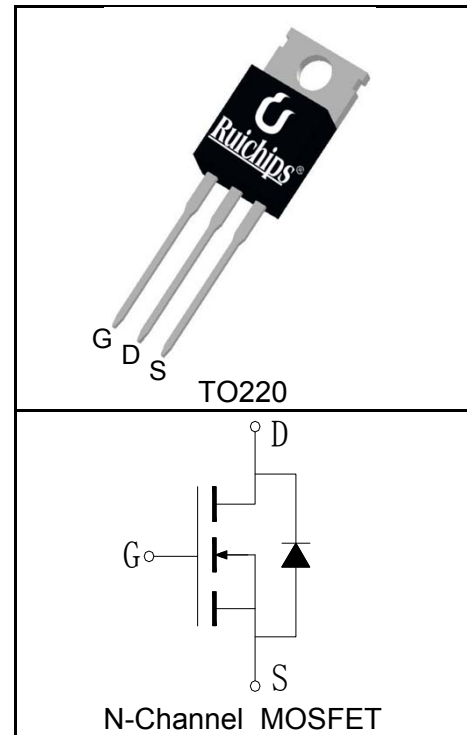

**Features**

- 40V/130A,
- $R_{DS(ON)} = 2.2m\Omega(Typ.)@V_{GS}=10V$
- $R_{DS(ON)} = 3.5m\Omega(Typ.)@V_{GS}=4.5V$
- Ultra Low On-Resistance
- Fast Switching Speed
- 100% avalanche tested
- Lead Free and Green Devices Available (RoHS Compliant)

**Pin Description**

**Applications**

- DC/DC Converters
- On board power for server
- Synchronous rectification

**Absolute Maximum Ratings**

Symbol	Parameter	Rating	Unit
<b>Common Ratings</b> ( $T_C=25^\circ C$ Unless Otherwise Noted)			
$V_{DSS}$	Drain-Source Voltage	40	V
$V_{GSS}$	Gate-Source Voltage	$\pm 20$	
$T_J$	Maximum Junction Temperature	175	$^\circ C$
$T_{STG}$	Storage Temperature Range	-55 to 175	$^\circ C$
$I_S$	Diode Continuous Forward Current	$T_C=25^\circ C$ 75	A
<b>Mounted on Large Heat Sink</b>			
$I_{DP}^{①}$	300 $\mu s$ Pulse Drain Current Tested	$T_C=25^\circ C$ 450	A
$I_D^{②}$	Continuous Drain Current( $V_{GS}=10V$ )	$T_C=25^\circ C$ 130	A
		$T_C=100^\circ C$ 81	
$P_D$	Maximum Power Dissipation	$T_C=25^\circ C$ 158	W
		$T_C=100^\circ C$ 79	
$R_{\theta JC}$	Thermal Resistance-Junction to Case	0.95	$^\circ C/W$
$R_{\theta JA}$	Thermal Resistance-Junction to Ambient	62.5	$^\circ C/W$
<b>Drain-Source Avalanche Ratings</b>			
$E_{AS}^{③}$	Avalanche Energy, Single Pulsed	380	mJ

**Electrical Characteristics** ( $T_C=25^\circ\text{C}$  Unless Otherwise Noted)

Symbol	Parameter	Test Condition	RUH40130R			Unit
			Min.	Typ.	Max.	
<b>Static Characteristics</b>						
$BV_{DSS}$	Drain-Source Breakdown Voltage	$V_{GS}=0V, I_{DS}=250\mu A$	40			V
$I_{DSS}$	Zero Gate Voltage Drain Current	$V_{DS}=40V, V_{GS}=0V$			1	$\mu A$
		$T_J=125^\circ C$			30	
$V_{GS(th)}$	Gate Threshold Voltage	$V_{DS}=V_{GS}, I_{DS}=250\mu A$	1		3	V
$I_{GSS}$	Gate Leakage Current	$V_{GS}=\pm 20V, V_{DS}=0V$			$\pm 100$	nA
$R_{DS(ON)}^{(4)}$	Drain-Source On-state Resistance	$V_{GS}=10V, I_{DS}=75A$		2.2	2.5	$m\Omega$
		$V_{GS}=4.5V, I_{DS}=50A$		3.5	3.8	$m\Omega$
<b>Diode Characteristics</b>						
$V_{SD}^{(4)}$	Diode Forward Voltage	$I_{SD}=75A, V_{GS}=0V$			1.2	V
$t_{rr}$	Reverse Recovery Time	$I_{SD}=75A, di_{SD}/dt=100A/\mu s$		11		ns
$Q_{rr}$	Reverse Recovery Charge			17		nC
<b>Dynamic Characteristics</b> <sup>(5)</sup>						
$R_G$	Gate Resistance	$V_{GS}=0V, V_{DS}=0V, F=1MHz$		1.1		$\Omega$
$C_{iss}$	Input Capacitance	$V_{GS}=0V,$ $V_{DS}=20V,$ Frequency=1.0MHz		3450		pF
$C_{oss}$	Output Capacitance			1285		
$C_{rss}$	Reverse Transfer Capacitance			89		
$t_{d(ON)}$	Turn-on Delay Time	$V_{DD}=20V, I_{DS}=75A,$ $V_{GEN}=10V, R_G=4.7\Omega$		18		ns
$t_r$	Turn-on Rise Time			29		
$t_{d(OFF)}$	Turn-off Delay Time			106		
$t_f$	Turn-off Fall Time			25		
<b>Gate Charge Characteristics</b> <sup>(5)</sup>						
$Q_g$	Total Gate Charge	$V_{DS}=32V, V_{GS}=10V,$ $I_{DS}=75A$		87		nC
$Q_{gs}$	Gate-Source Charge			11		
$Q_{gd}$	Gate-Drain Charge			23		

- Notes:
- ① Pulse width limited by safe operating area.
  - ② Calculated continuous current based on maximum allowable junction temperature. The package limitation current is 75A.
  - ③ Limited by  $T_{Jmax}, I_{AS}=39A, V_{DD}=32V, R_G=50\Omega$ , Starting  $T_J=25^\circ C$ .
  - ④ Pulse test; Pulse width  $\leq 300\mu s$ , duty cycle  $\leq 2\%$ .
  - ⑤ Guaranteed by design, not subject to production testing.

**Ordering and Marking Information**

<b>Device</b>	<b>Marking</b>	<b>Package</b>	<b>Packaging</b>	<b>Quantity</b>	<b>Reel Size</b>	<b>Tape width</b>
RUH40130R	RUH40130R	TO220	Tube	50	-	-

**Typical Characteristics**

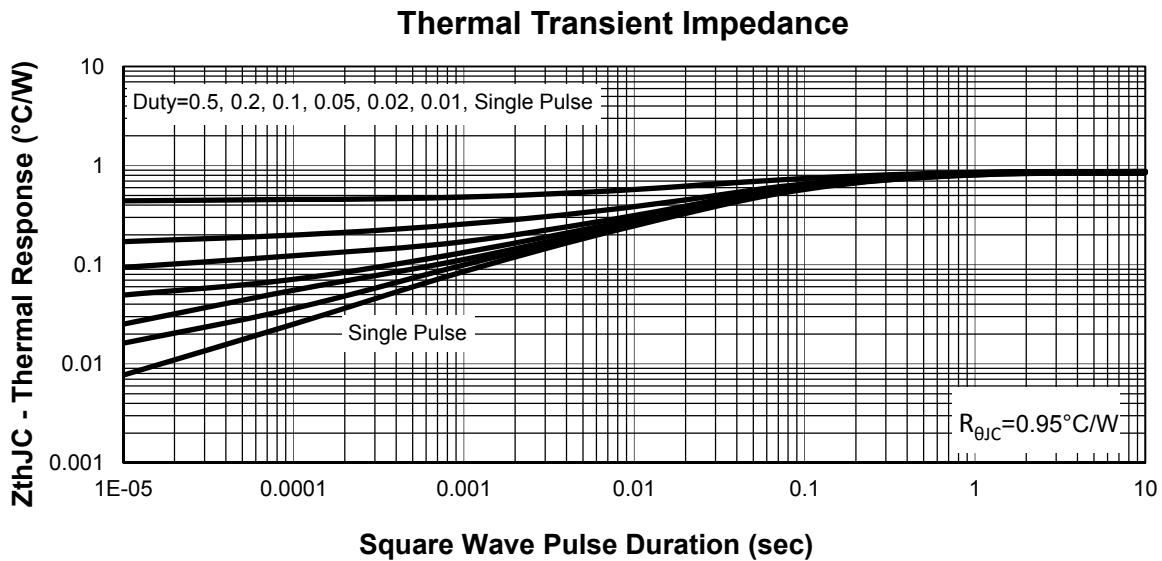
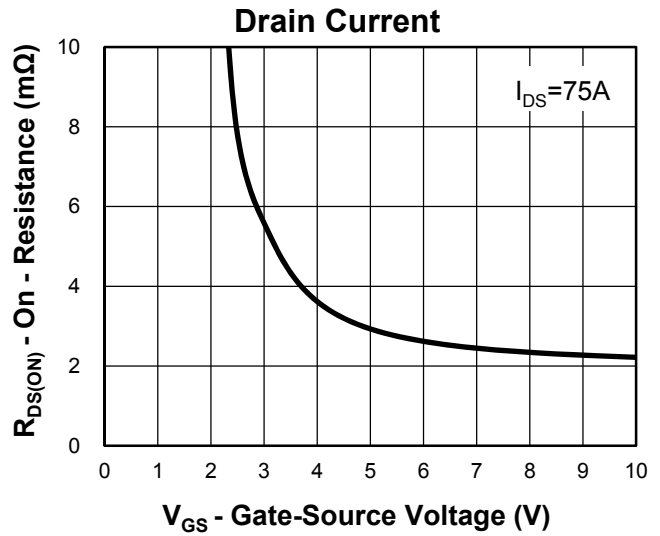
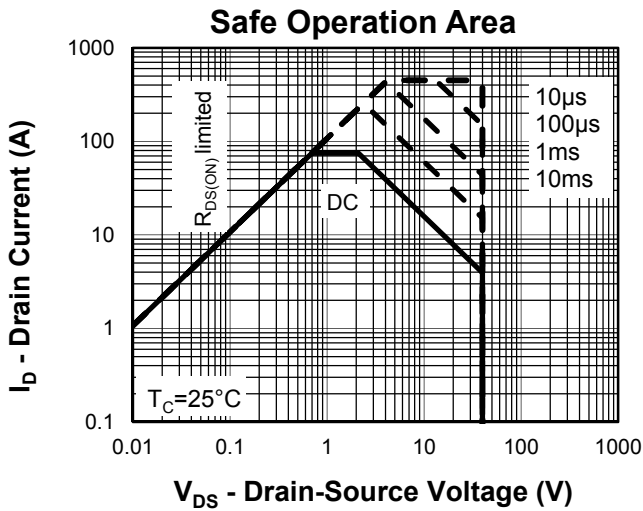
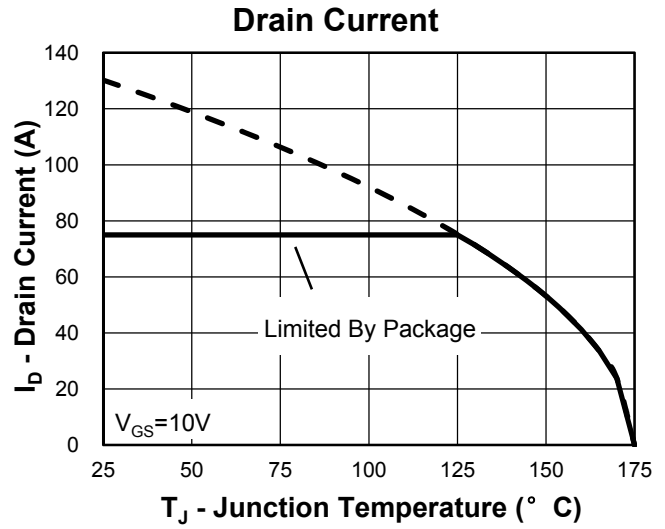
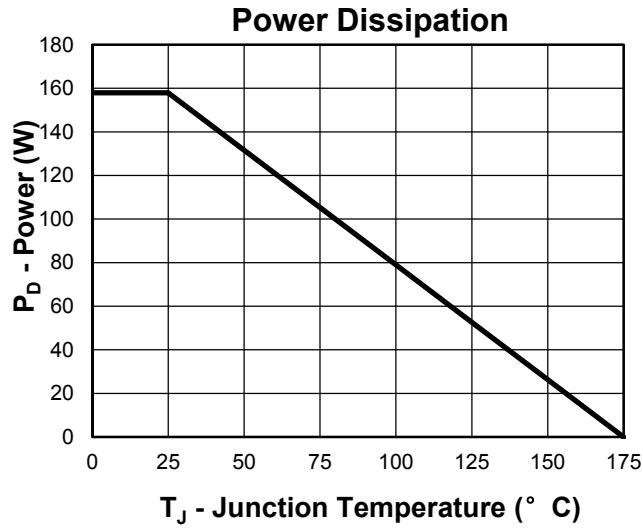

**Typical Characteristics**

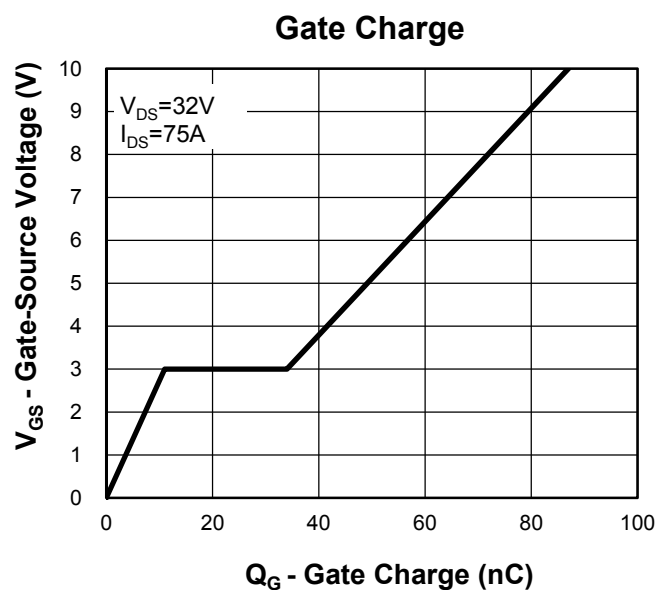
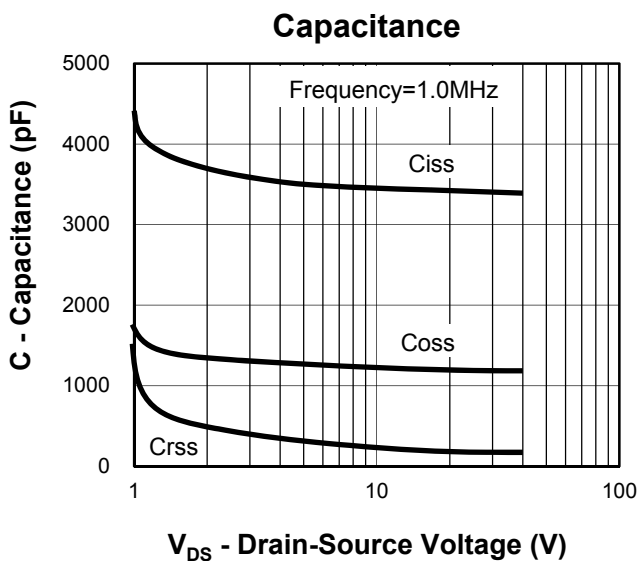
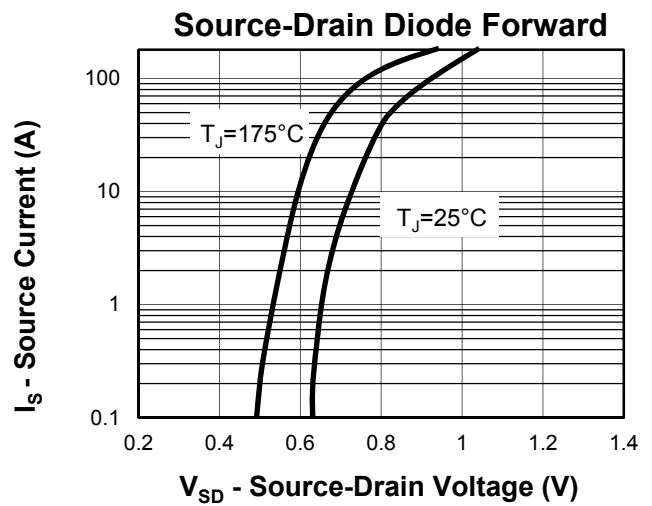
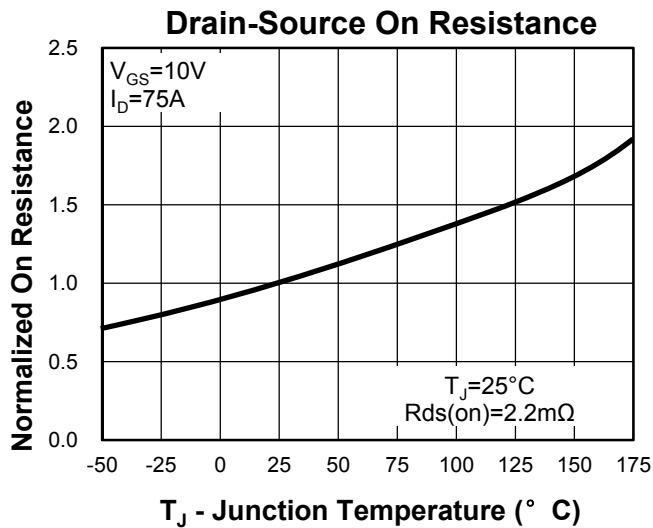
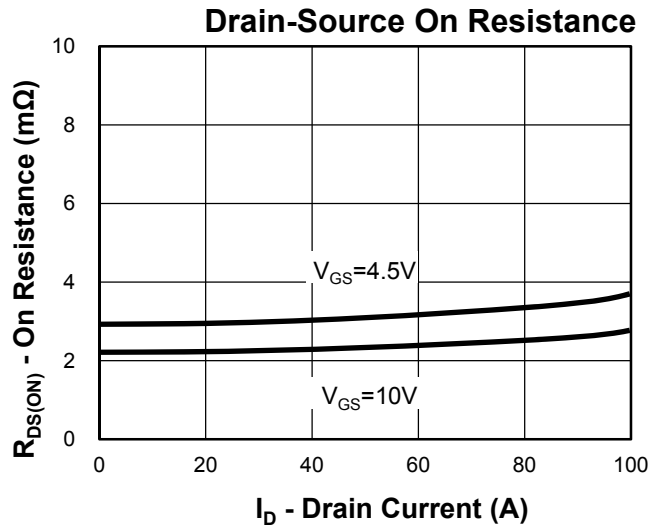
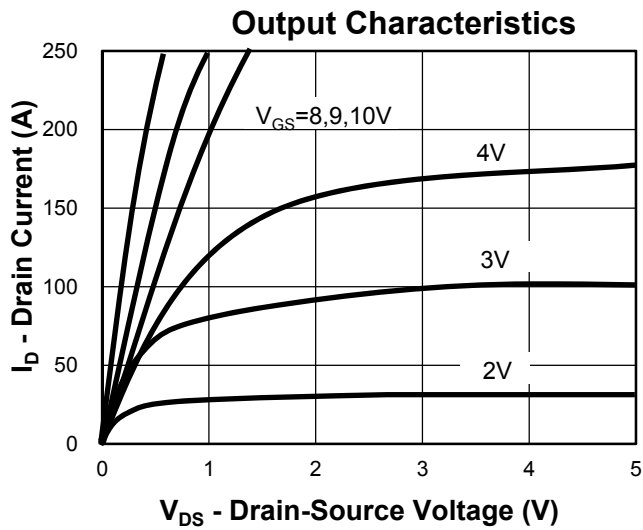

**Avalanche Test Circuit and Waveforms**

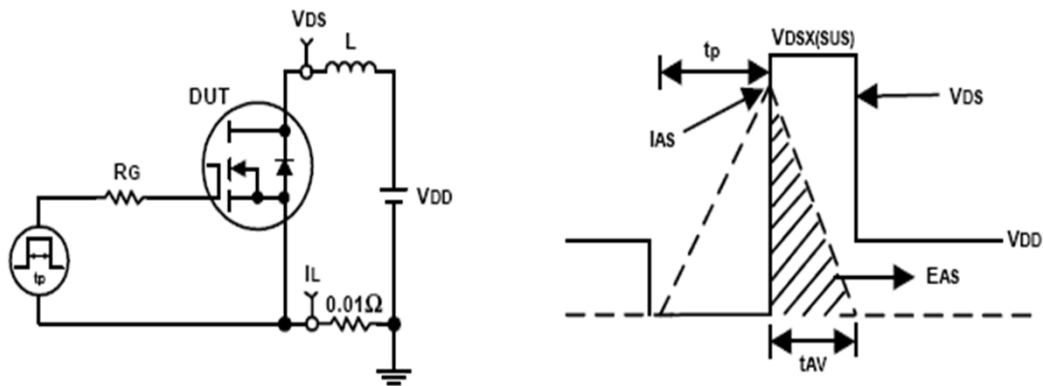

**Switching Time Test Circuit and Waveforms**

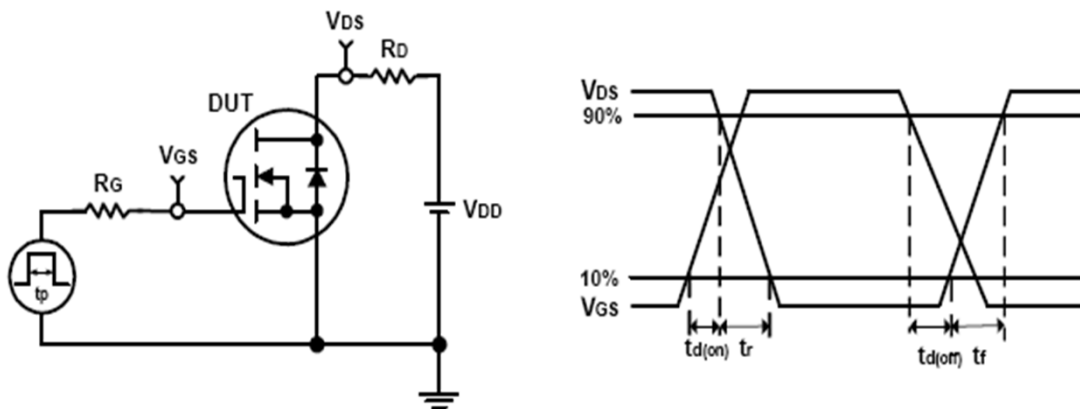

**Package Information**

**TO220**

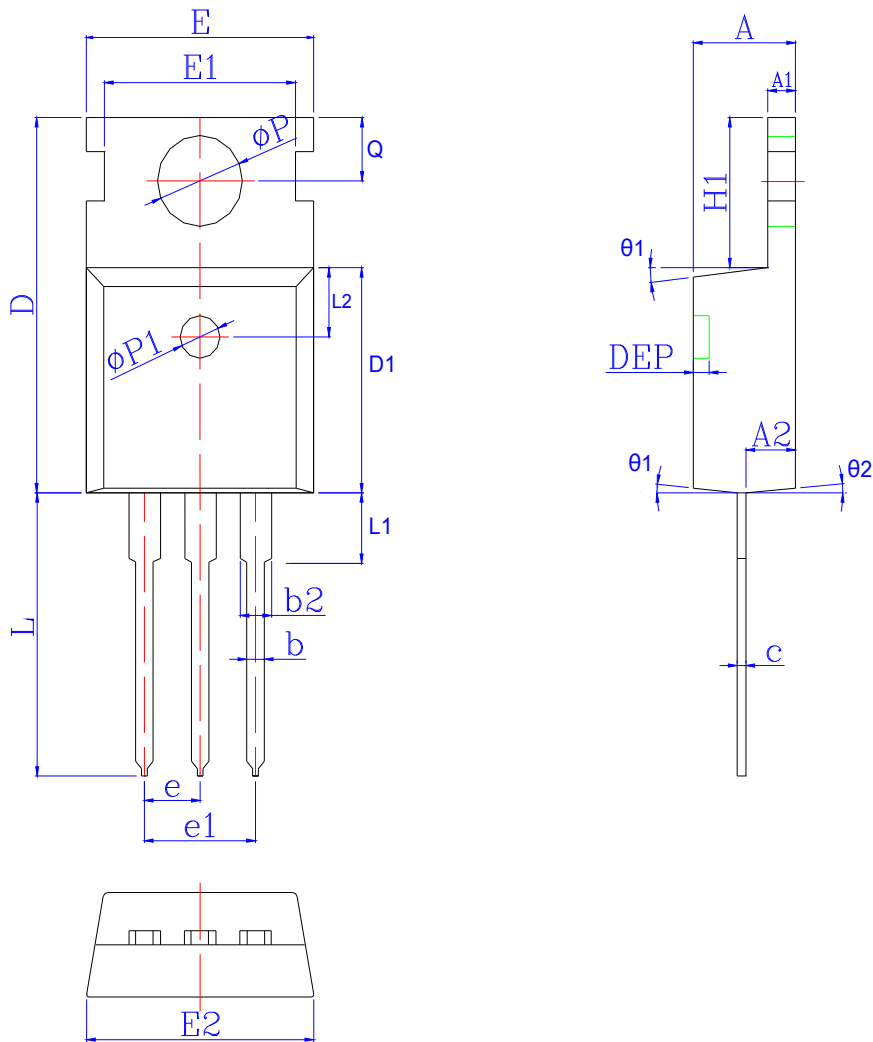

SYMBOL	MM			INCH			SYMBOL	MM			INCH		
	MIN	NOM	MAX	MIN	NOM	MAX		MIN	NOM	MAX	MIN	NOM	MAX
A	4.30	4.50	4.70	0.169	0.177	0.185	$\Phi p1$	1.40	1.50	1.60	0.055	0.059	0.063
A1	1.15	1.30	1.40	0.045	0.051	0.055	e	2.54 BSC			0.10 BSC		
A2	1.90	2.25	2.60	0.075	0.089	0.102	e1	5.08 BSC			0.20 BSC		
b	0.60	0.80	1.00	0.024	0.031	0.039	H1	6.35	6.50	6.80	0.250	0.256	0.268
b2	1.17	1.28	1.72	0.046	0.050	0.068	L	12.70	13.18	13.65	0.500	0.519	0.537
c	0.40	0.50	0.60	0.016	0.020	0.024	L1	*	*	3.95	*	*	0.156
D	15.40	15.70	16.00	0.606	0.618	0.630	L2	2.50 REF			0.098 REF		
D1	8.96	9.21	9.46	0.353	0.363	0.372	$\Phi p$	3.50	3.60	3.75	0.138	0.142	0.148
DEP	*	*	0.30	*	*	0.012	Q	2.70	2.80	3.20	0.106	0.110	0.126
E	9.66	9.97	10.28	0.380	0.393	0.405	$\theta 1$	5°	7°	9°	5°	7°	9°
E1	*	8.70	*	*	0.343	*	$\theta 2$	1°	3°	5°	1°	3°	5°
E2	9.80	10.00	10.20	0.386	0.394	0.402							

**Customer Service****Worldwide Sales and Service:**

Sales@ruichips.com

**Technical Support:**

Technical@ruichips.com

**Investor Relations Contacts:**

Investor@ruichips.com

**Marcom Contact:**

Marcom@ruichips.com

**Editorial Contact:**

Editorial@ruichips.com

**HR Contact:**

HR@ruichips.com

**Legal Contact:**

Legal@ruichips.com

**Shen Zhen RUICHIPS Semiconductor CO., LTD**

4th Floor, Block 8, Changyuan New Material Port, Keyuan Middle Road, Science & Industry Park,  
Nanshan District, Shenzhen, CHINA

**TEL:** (86-755) 8311-5334**FAX:** (86-755) 8311-4278**E-mail:** Sales-SZ@ruichips.com